

USER AND MAINTENANCE MANUAL: Sun/wind anemometer for 1 or 2 motors

ENG

595.K.F2.00

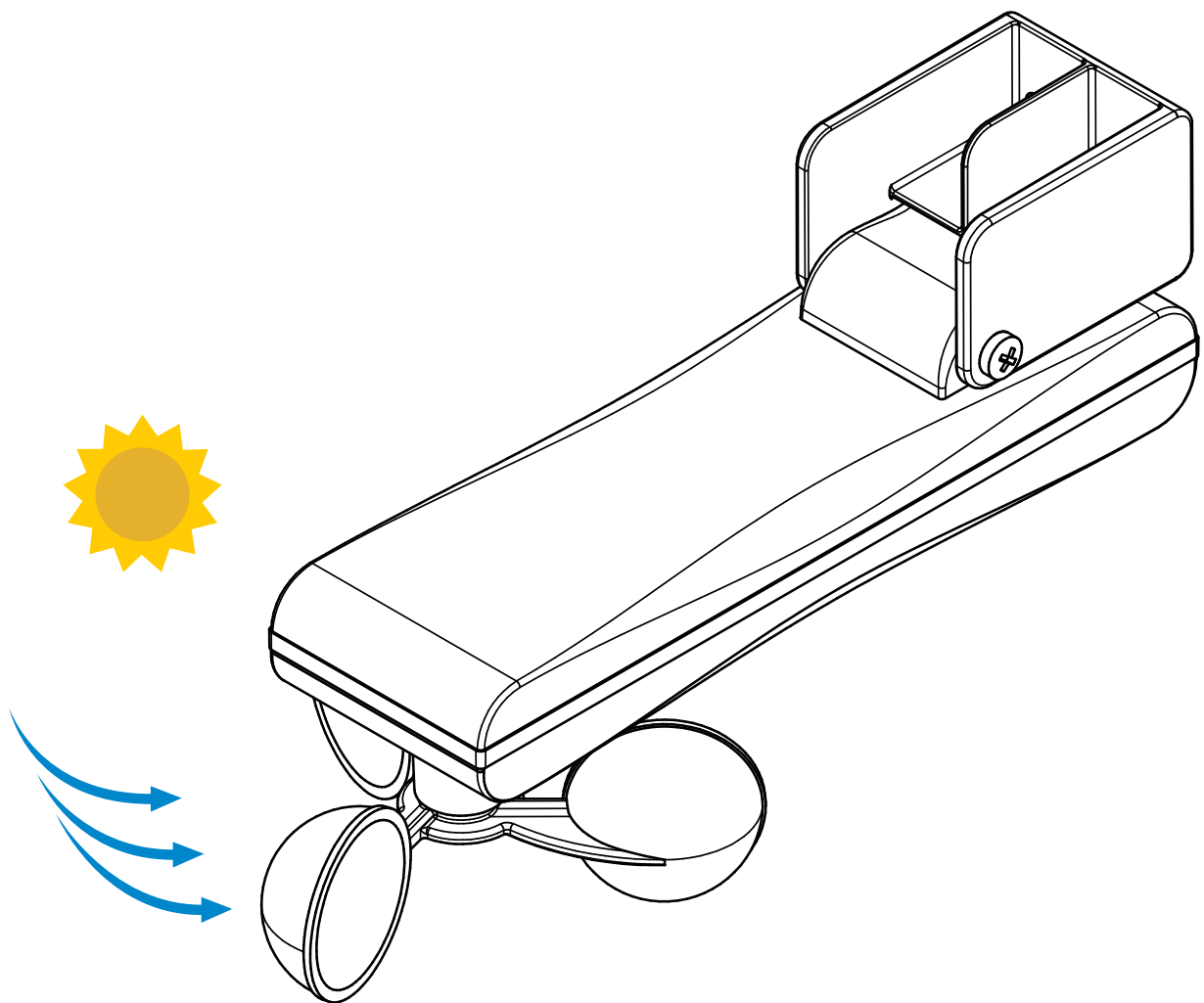

595.K.F2.00

Dear Customer, thank you for purchasing a Stafer S.p.A. product. This guide contains information about the use of the product. Before installing and using the product, please read this guide carefully and keep it for future reference.

595.K.F2.00 is a sun/wind sensor designed to operate tubular motors with mechanical limit switch powered by main voltage, and suitable to operate awnings, blinds or similar products. 595.K.F2.00 allows operating the automatic retraction of rolling shutters connected to the motor when the wind exceeds the set threshold, as well as their release when the intensity of sun exceeds the set threshold. These thresholds are set by the factory, but they can be adjusted according to the needs.

WARNING!!

This sensor does not protect shutters in case of strong and sudden wind gusts.
In case of weather hazards of this type, make sure that shutters remain closed! Stafer S.p.A. declines all liability for damage incurred due to weather events not detected by the device.

Any other use beyond the field defined by Stafer S.p.A. is prohibited and involves, as well as the failure to comply with instructions provided in this guide, avoidance of Stafer S.p.A.'s liability and warranty. The installer, after the installation of the product, must train the end user about the use of the automation and provide him with the User and maintenance manual.

Index	
01 Warnings	page 01
02 Assembly instructions	page 02
03 Electrical connections	page 02
04 Interfacing with home automation control units	page 04
05 WIND sensor	page 04
05.1 How to change the wind threshold	
05.2 Visual LED signals associated with the wind sensor	
05.3 Forced exit from the wind alarm	
06 SUN function	page 05
06.1 Activation/deactivation of "sun" function	
06.2 How to change the sun threshold	
06.3 Visual LED signals associated with the "sun" function	
07 Automatic lowering function after wind alarm	page 06
08 Operating logic of command buttons	page 06
09 Factory values reset	page 07

Technical specifications

✓ Power supply:	120 or 230 Vac, 50/60 Hz
✓ Dimensions:	240 x 60 x H.111/133 mm
✓ Weight:	230 g
✓ Operating temperature:	from -20 to +55 °C
✓ Protection degree:	IP 55
✓ Wind threshold:	from 5 to 35 km/h
✓ Sun threshold:	from 1 to 45 Klux

Let's protect the environment!

STAFER uses recyclable packaging materials. Dispose of materials in proper containers, in compliance with laws in force in your location. If you are an installer and use a large number of motors, ask your dealer about receiving motors in "honeycomb pads", an environmentally friendly choice that limits clutter and waste by reducing the amount of packaging materials.

This product may have substances that are polluting for the environment and dangerous for the health. At the end of the product life cycle, carefully comply with local waste disposal rules. It is strictly forbidden to dispose of the product in the domestic waste.



01. WARNINGS. WARNING!

01.1 SAFETY WARNINGS

- ✓ Incorrect installation can cause serious injuries.
- ✓ Keep these instructions for future maintenance operations and the disposal of the product.
- ✓ All the product installation, connection, programming and maintenance operations must be carried out only by a qualified and skilled technician, who must comply with laws, provisions and local regulations, and the instructions provided herein.
- ✓ Wiring must comply with current CEI standards. In compliance with the provisions of Italian Ministerial Decree 37/2008, the final electrical system must be installed only by an electrician.
- ✓ Some applications require "man present" operation and can exclude the use of radio commands or require particular safety devices.
- ✓ To prevent potentially dangerous situations, regularly check the operating condition of the rolling shutter/awning.

01.2 INSTALLATION WARNINGS

- ✓ Read the technical specifications in paragraph "Technical Specifications" to evaluate the operating parameters of the product.
- ✓ Before installing the product, check compatibility with associated devices and accessories.
- ✓ The motor connected to the device must be of the "mechanical limit switch" type, without any electronic control; the motor must be of power adequate to the charge (check the rating plate data on the motor).
- ✓ Check that the package is intact and has not been damaged during transport.
- ✓ A heavy shock, falls, crushing and the use of unsuitable tools can cause the damage of the external or internal parts of the product.
- ✓ Do not pierce or tamper with the product in any way. Do not modify or replace parts without the Manufacturer's permission.
- ✓ Check that the location selected for product installation enables the blades to be exposed to the same wind to which the rolling shutter to be motorized is exposed.
- ✓ Check that the installation location is made of solid materials and can ensure a stable installation.
- ✓ Do not install the product near heat sources (such as chimneys, etc...).
- ✓ Adjust the control unit inclination so that blades are positioned horizontally.
- ✓ The wind detection blades must face downward. The blades must be free to rotate without obstruction.
- ✓ Check that the control unit is placed in a protected position from accidental impact with other objects (e.g. branches, etc.).
- ✓ The power cable must be positioned in such a way as to avoid contact with moving parts.
- ✓ Do not use abrasive or solvent products for cleaning the device; do not clean using water-jet or high-pressure cleaners.
- ✓ For your safety, do not work near the coiler while the motor is powered.

01.3 USE WARNINGS

- ✓ The product is not intended to be used by persons (including children) with reduced physical, sensory or mental capabilities, or lack of experience and knowledge, unless they are supervised or given instructions about the product way of use by a person responsible for their safety.
- ✓ Check automation during operation and keep people at a safe distance, until operation ends.
- ✓ Do not allow children to play with the appliance or with the fixed control devices.
- ✓ Do not operate the rolling shutter when maintenance operations are being carried out (e.g. window cleaning, etc.). If the control device is automatic, disconnect the motor from the power line.

02. ASSEMBLY INSTRUCTIONS

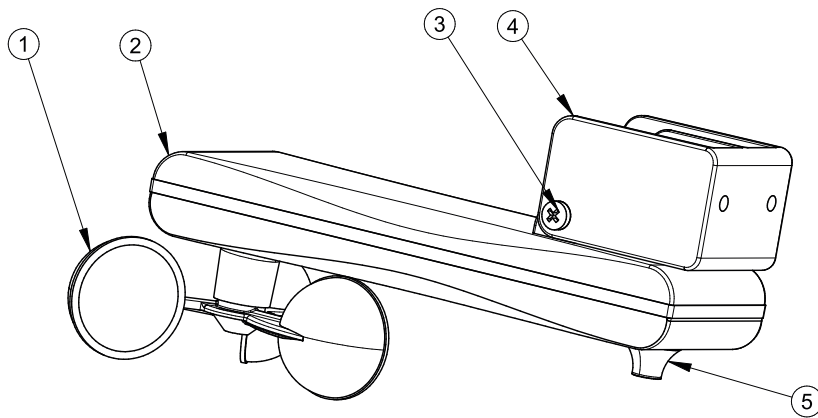

Components key:

- (1) Impeller
- (2) Anemometer body
- (3) Support fastening screw
- (4) Wall fastening support
- (5) Rubber cable entry

02.1 LED DIAGRAM

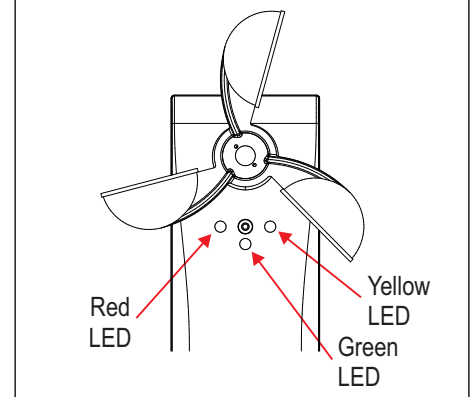

02.2 FASTENING SYSTEMS

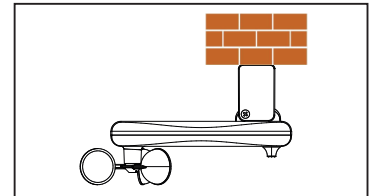
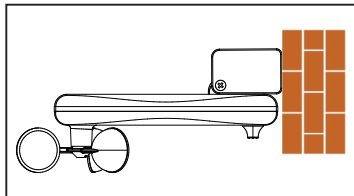
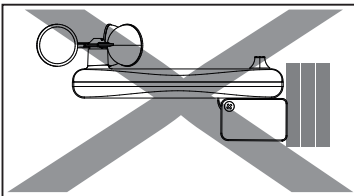

02.3 ASSEMBLY INSTRUCTIONS

The anemometer is normally supplied already wired. If not, follow the instructions below.

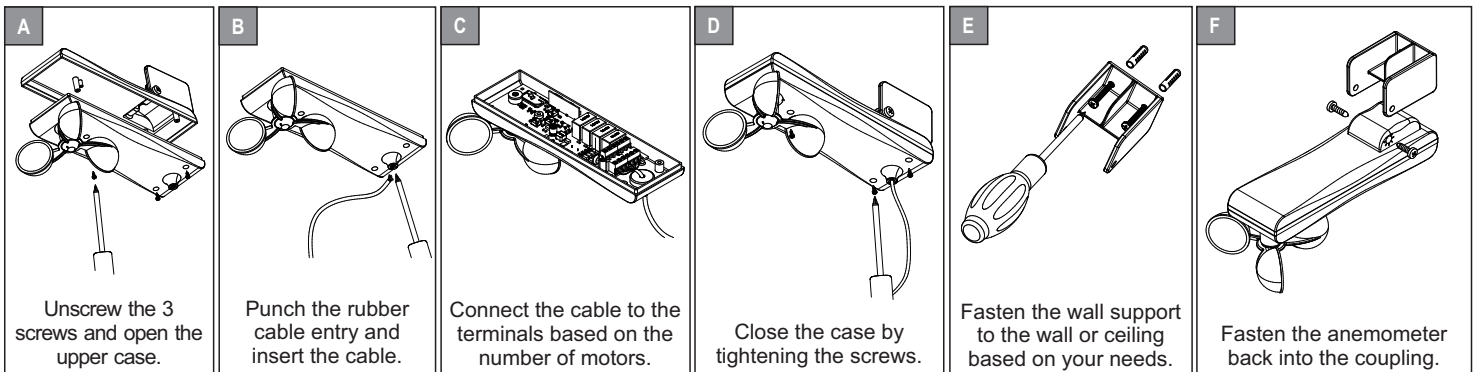

Notes:

- ✓ the product has been designed to be installed with blades facing downward. Moreover, the sensor body must be adjusted horizontally.
- ✓ the bore interaxis is 25 mm.
- ✓ as soon as the anemometer is powered, the three coloured LEDs will briefly flash 3 times.

03. ELECTRICAL CONNECTION



- ✓ Make all connections with the power supply disconnected.
- ✓ Check that the power line does not feed on electrical circuits to be used for lighting.
- ✓ Always connect the motor to the grounding system (yellow/green).
- ✓ The power line must be equipped with a magnetothermal or differential circuit breaker. A category III overvoltage disconnection device must be fitted on the power supply line, i.e. at a distance of at least 3.5 mm between the contacts.
- ✓ The product does not provide for any protection against overloads or short circuits. Provide adequate protection for the load on the power supply line, for example a fuse with a maximum value of 3.15A (for 1 motor) or 6.3A (for 2 motors).
- ✓ The section of the connecting cables must be proportionate to their length and to the power load absorption, and, in any case, not less than 1.5 mm.
- ✓ **You must use command buttons with spring return (“man present” type), do NOT use switches with maintained position.**
- ✓ Command buttons are connected to the main voltage, so they must be properly insulated and protected.
- ✓ **Once the electrical connections are finished, bring the motor/motors to intermediate position and check that in the “wind alarm” condition the module controls the upward movement of the motor/motors (to exit the “wind alarm”, disconnect power for a few seconds).**

Below is the combination of colored cables with the corresponding controls.

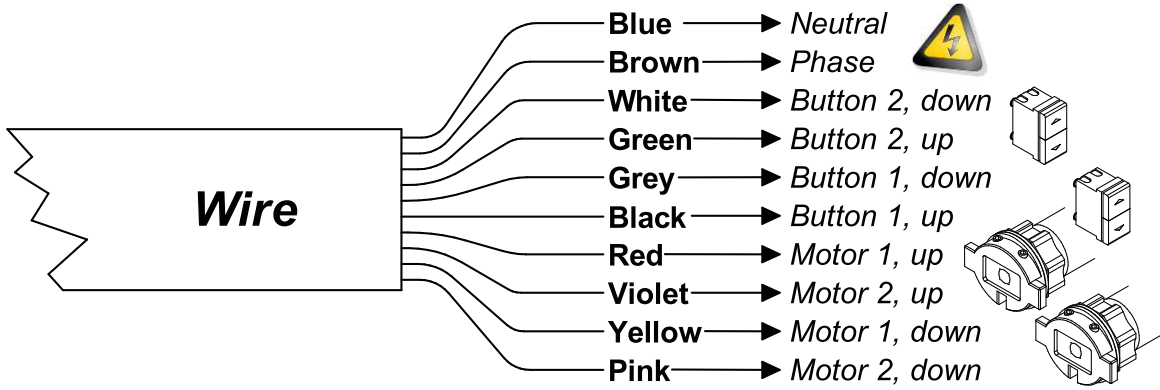

1 MOTOR CONNECTION

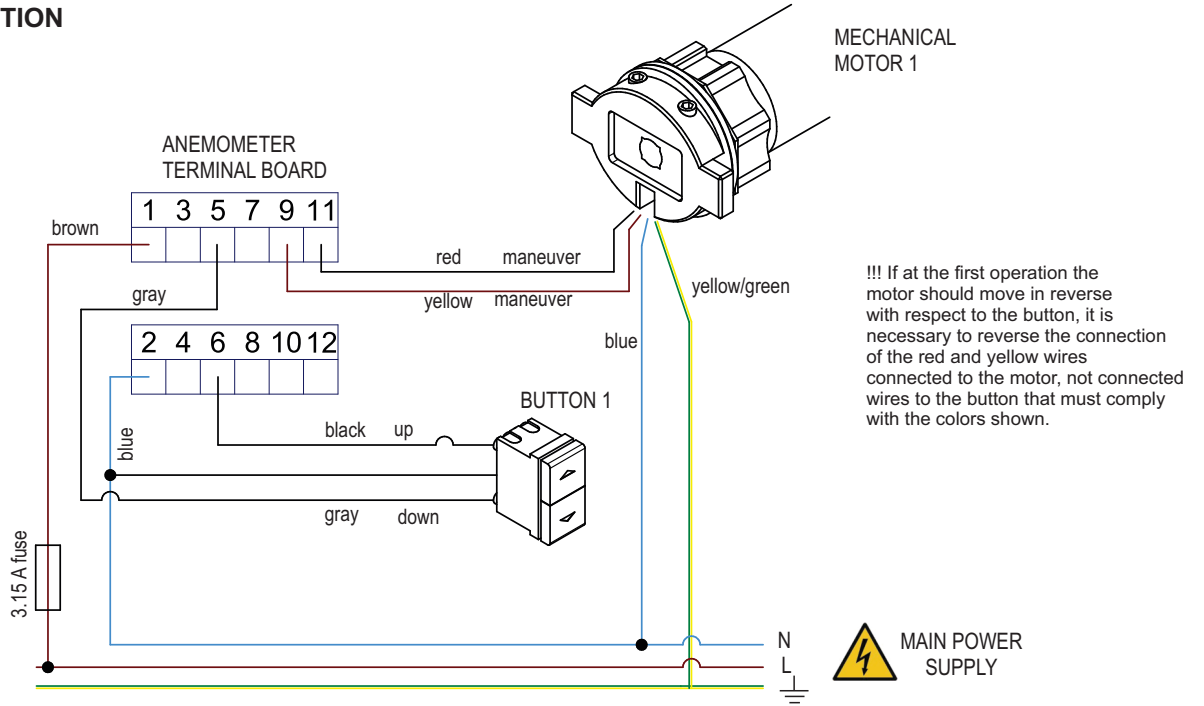

2 MOTORS CONNECTION

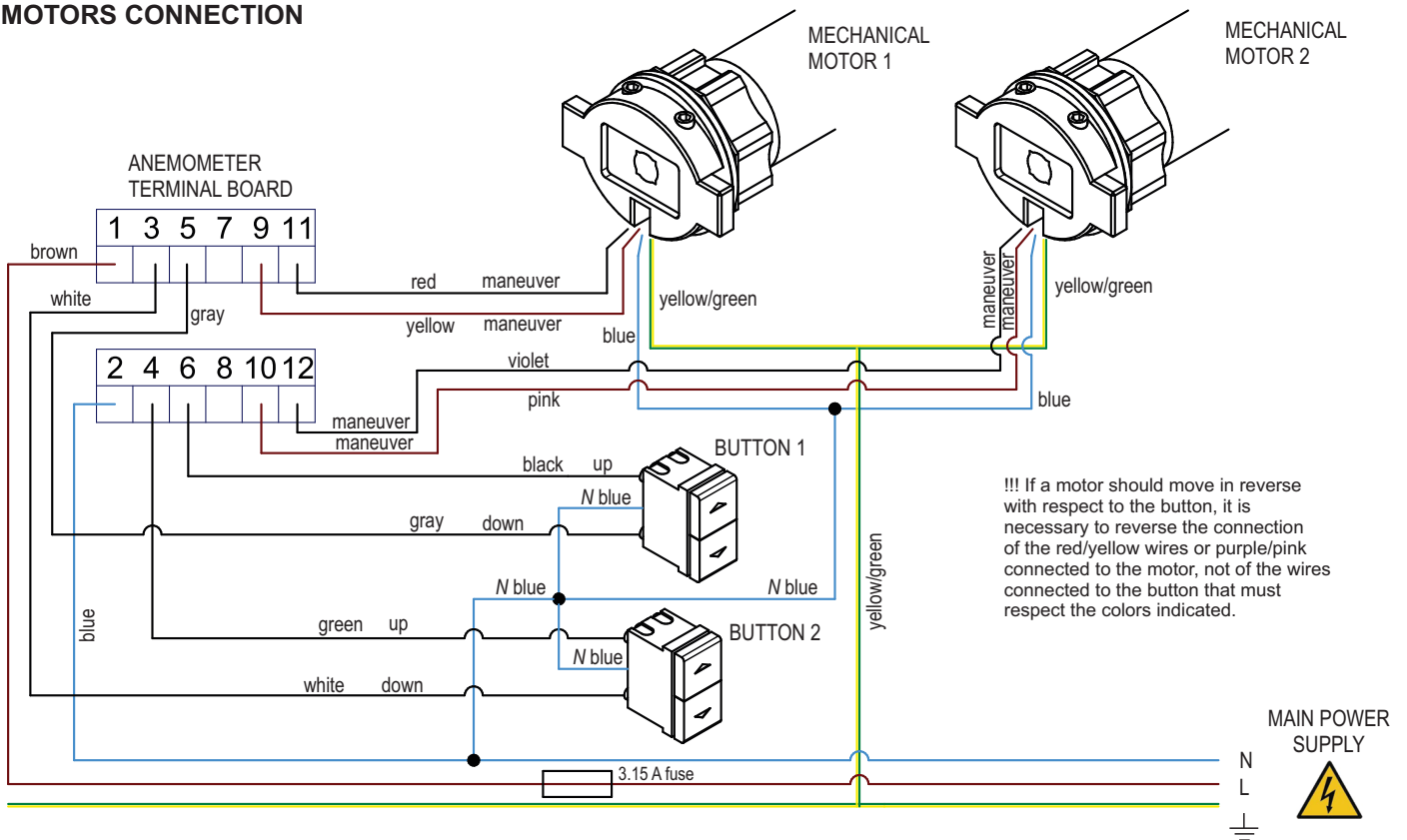

04. INTERFACING WITH HOME AUTOMATION CONTROL UNITS

- ✓ This device can be interfaced to the most widespread home automation control units through the wires of the command buttons (it is still necessary to check beforehand the compatibility, assessing whether the home automation control unit is able to provide appropriate signals to the device).
- ✓ **Warning:** Before making any connections between your device and the home automation control unit you need to choose the operating logic of the buttons that will best suit your home automation system ("pulse" or "man present" logic, see section 8 "Operating logic of command buttons").
- ✓ If you select the "pulse" operating logic (factory setting), the home automation control unit must be able to generate timed signals on the contacts for the buttons (greater than 0.5 sec to start the manoeuvre, less than 0.5 sec to stop the manoeuvre). If your home automation system does not have this feature, you must set the device to operate in "man present" logic.
- ✓ Note that the **OPEN** and **CLOSE** contacts of the home automation control unit, connected to the wires of the command buttons on the device, must close on phase.

05. WIND SENSOR

If wind speed is above the set threshold for at least 15 seconds, an upward movement is activated to protect the awning (wind alarm). During this phase, **all manual commands are disabled**. The control unit exits the "wind alarm" if the wind speed keeps below the set threshold for at least 5 minutes. The wind threshold ranges from 5 km/h to 35 km/h. The factory sets the wind threshold at level 2.

05.1 HOW TO CHANGE THE WIND THRESHOLD

A

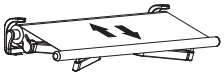

Bring the motor to the intermediate position.

B

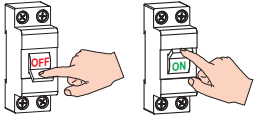

Switch OFF power supply for few seconds, then switch it ON again.

C ⁽¹⁾

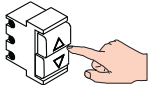

3 x UP
3 x DOWN

Within 15 seconds press 3 times on UP and 3 times on DOWN.

D



The motor completes 1 up/down movement.

E ⁽¹⁾

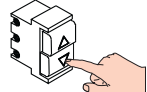

2 x UP
1 x DOWN

Within 15 seconds press twice on UP and once on DOWN.

F



After 15 seconds the motor completes 1 up/down movement.

G

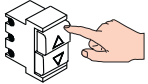

1 x UP

Within 15 seconds press once on UP

H

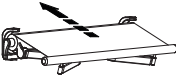

The motor shows the current setting (from 1 to 5 movements).

I ⁽²⁾

WITHIN 15 SECONDS, SELECT THE DESIRED SETTING BY PRESSING UP FROM 1 TO 5 TIMES

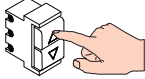
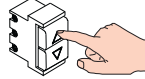
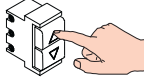
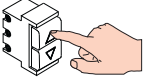
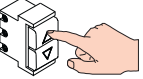
5 Km/h <small>VERY SENSIBLE</small>	10 Km/h	15 Km/h	25 Km/h	35 Km/h
 1 x UP	 2 x UP	 3 x UP	 4 x UP	 5 x UP

L



See Tab. 01

The motor shows the new setting (from 1 to 5 movements). Wait 10 seconds

Tab. 01 - Wind threshold

No. of movements	Threshold
1	5 km/h
2	10 Km/h
3	15 Km/h
4	25 Km/h
5	35 Km/h

If you try to set a wind threshold higher than 35 Km/h, the value rejects the operation and completes 4 short up/down movements.

Notes:

- 1) Button must be pressed shortly, approx. 0,5 seconds between two pressures.
- 2) Button must be pressed shortly, approx. 0,5 seconds between two pressures. If you do not want to change the setting, wait 15 seconds without pressing any button.

05.2 VISUAL LED SIGNALS ASSOCIATED WITH THE WIND SENSOR

YELLOW LED on steady: the sun function is active (regardless of awning position).
 YELLOW LED off: the sun function is not active (regardless of awning position).
 RED LED flashing: anemometer in wind alarm mode

05.3 FORCED EXIT FROM THE WIND ALARM

It is possible to exit the "wind alarm" mode without waiting for the 5 minutes required for the wind to go below the threshold, removing voltage from the device and waiting a few seconds before switching on again. Then wait 15 seconds before giving any command.

06. SUN FUNCTION

The “sun” function allows the awning to move automatically according to sun exposure, based on brightness measured by the light sensor installed on the anemometer. This function is deactivated by default and can be activated at a later time. If the intensity of the sun is above the set threshold for at least 2 minutes, an automatic downward manoeuvre is performed; if the intensity of the sun is below the set threshold for at least 15 minutes, an automatic upward manoeuvre is performed. Once an automatic downward manoeuvre for the presence of the sun is performed, the next automatic manoeuvre performed by the control unit will be an upward movement for absence of sun and so on. The user can, in any case, operate the awning, without the manual command affecting the operating logic of the sun sensor. The sun threshold ranges from 1 to 45 Klux. The factory sets the sun threshold to level 2. In the event of a wind alarm, the awning will be closed whether or not any sun is shining.



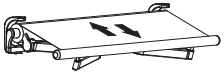
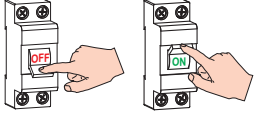
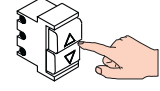
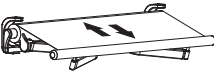
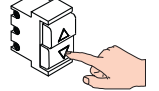
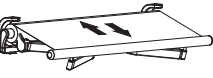
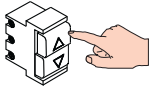
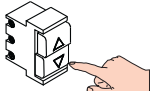
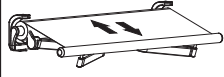
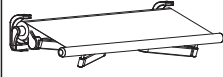

06.1 ACTIVATION/DEACTIVATION OF “SUN” FUNCTION

<p>A</p>  <p>Bring the motor to the intermediate position.</p>	<p>B</p>  <p>Switch OFF power supply for few seconds, then switch it ON again.</p>	<p>C ⁽¹⁾</p>  <p>3 x UP 3 x DOWN</p> <p>Within 15 seconds press 3 times on UP and 3 times on DOWN.</p>	<p>D</p>  <p>The motor completes 1 up/down movement.</p>	<p>E ⁽¹⁾</p>  <p>2 x UP 2 x DOWN</p> <p>Within 15 seconds press twice on UP and twice on DOWN.</p>	<p>F</p>  <p>After 15 seconds the motor completes 1 up/down movement.</p>
<p>G</p> <p>To ACTIVATE the sun function:</p>  <p>1 x UP</p>	<p>To DEACTIVATE the sun function:</p>  <p>1 x DOWN</p>	<p>H</p>  <p>The motor replicates the up or down movement.</p>	<p>I</p>  <p>Do not press anything and wait 10 seconds. The motor exits the menu without signaling.</p>		

Notes:

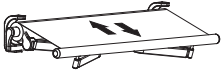
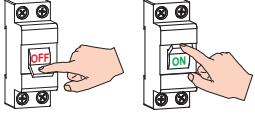
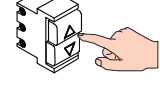
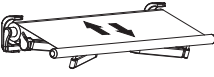
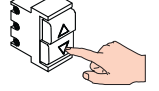
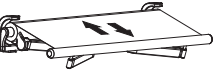
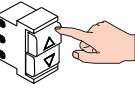
(1) Button must be pressed shortly, approx. 0,5 seconds between two pressures.

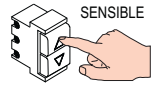
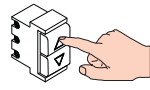
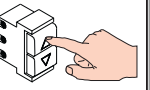
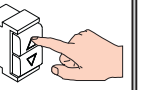
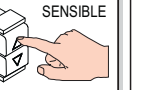
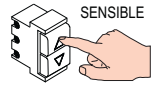
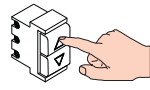
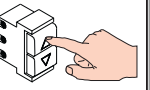
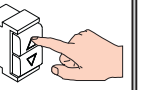
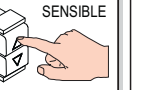
06.2 HOW TO ADJUST THE “SUN” THRESHOLD

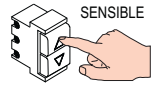
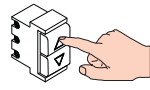
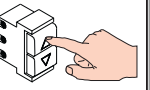
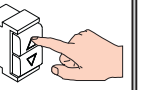
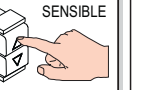
<p>A</p>  <p>Bring the motor to the intermediate position.</p>	<p>B</p>  <p>Switch OFF power supply for few seconds, then switch it ON again.</p>	<p>C ⁽¹⁾</p>  <p>3 x UP 3 x DOWN</p> <p>Within 15 seconds press 3 times on UP and 3 times on DOWN.</p>	<p>D</p>  <p>The motor completes 1 up/down movement.</p>	<p>E ⁽²⁾</p>  <p>2 x UP 3 x DOWN</p> <p>Within 15 seconds press twice on UP and 3 times on DOWN.</p>	<p>F</p>  <p>After 15 seconds the motor completes 1 up/down movement.</p>										
<p>G</p>  <p>1 x UP</p> <p>Within 15 seconds press once on UP</p>	<p>H</p>  <p>The motor shows the current setting (from 1 to 5 movements).</p>	<p>I ⁽²⁾</p> <p>WITHIN 15 SECONDS, SELECT THE DESIRED SETTING BY PRESSING UP FROM 1 TO 5 TIMES</p> <table border="1" data-bbox="432 1554 1305 1778"> <tr> <th>Level 1 (1 Klux)</th> <th>Level 2</th> <th>Level 3</th> <th>Level 4</th> <th>Level 5 (45 Klux)</th> </tr> <tr> <td>  <p>VERY SENSIBLE</p> <p>1 x UP</p> </td> <td>  <p>2 x UP</p> </td> <td>  <p>3 x UP</p> </td> <td>  <p>4 x UP</p> </td> <td>  <p>NOT VERY SENSIBLE</p> <p>5 x UP</p> </td> </tr> </table>			Level 1 (1 Klux)	Level 2	Level 3	Level 4	Level 5 (45 Klux)	 <p>VERY SENSIBLE</p> <p>1 x UP</p>	 <p>2 x UP</p>	 <p>3 x UP</p>	 <p>4 x UP</p>	 <p>NOT VERY SENSIBLE</p> <p>5 x UP</p>	<p>L</p>  <p>See Tab. 01</p> <p>The motor shows the new setting (from 1 to 5 movements). Wait 10 seconds</p>
Level 1 (1 Klux)	Level 2	Level 3	Level 4	Level 5 (45 Klux)											
 <p>VERY SENSIBLE</p> <p>1 x UP</p>	 <p>2 x UP</p>	 <p>3 x UP</p>	 <p>4 x UP</p>	 <p>NOT VERY SENSIBLE</p> <p>5 x UP</p>											

Tab. 02 - Sun threshold

No. of movements	1	2	3	4	5
Threshold	Lev. 1	Lev. 2	Lev. 3	Lev. 4	Lev. 5

Notes:

(1) Button must be pressed shortly, approx. 0,5 seconds between two pressures.

(2) Button must be pressed shortly, approx. 0,5 seconds between two pressures. If you do not want to change the setting, wait 15 seconds without pressing any button.

06.3 VISUAL LED SIGNALS ASSOCIATED WITH THE SUN SENSOR

YELLOW LED on steady: the sun function is active (regardless of awning position).

YELLOW LED off: the sun function is not active (regardless of awning position).

RED LED flashing: anemometer in wind alarm mode







07. AUTOMATIC LOWERING FUNCTION AFTER WIND ALARM

This device allows lowering the awning automatically after it retracted due to a wind alarm.

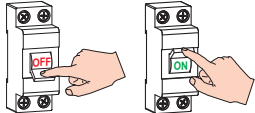
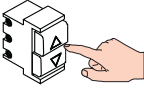
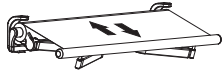
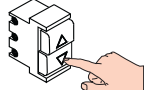
After 5 minutes without wind, either of two situations can occur:

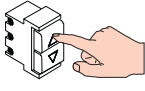
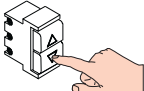
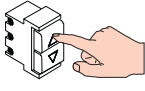
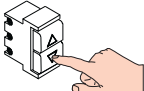
- If the sun sensor was activated, it will re-open the awning only if the awning was open when the wind was detected (if it was already closed, it will remain closed).
- If the sun sensor was deactivated, the awning will be automatically re-opened only if it was open when the wind was detected (if it was already closed, it will remain closed).

The automatic lowering function can be activated or deactivated. The factory sets it on ACTIVE mode. To change it, follow the procedure below.

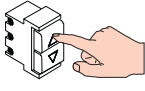
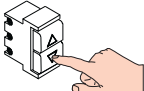
<p>A</p>  <p>Bring the motor to the intermediate position.</p>	<p>B</p>  <p>Switch OFF power supply for few seconds, then switch it ON again.</p>	<p>C ⁽¹⁾</p>  <p>3 x UP 3 x DOWN</p> <p>Within 15 seconds press 3 times on UP and 3 times on DOWN.</p>	<p>D</p>  <p>The motor completes 1 up/down movement.</p>	<p>E ⁽¹⁾</p>  <p>2 x UP 4 x DOWN</p> <p>Within 15 seconds press twice on UP and 4 times on DOWN.</p>		
<p>F</p> <p>After 15 seconds the motor shows the current setting.</p>  <p>x1 1 UP Function active</p>  <p>x1 1 DOWN Function NOT active</p>	<p>G WITHIN 5 SECONDS SELECT THE DESIRED SETTING BY PRESSING</p> <table border="1" style="width: 100%; border-collapse: collapse;"> <tr> <td style="width: 50%; padding: 5px;"> <p style="background-color: #ccc; text-align: center; margin: 0;">"To activate"</p>  <p style="text-align: center; margin: 0;">PRESS UP</p> </td> <td style="width: 50%; padding: 5px;"> <p style="background-color: #ccc; text-align: center; margin: 0;">"To deactivate it"</p>  <p style="text-align: center; margin: 0;">PRESS DOWN</p> </td> </tr> </table>		<p style="background-color: #ccc; text-align: center; margin: 0;">"To activate"</p>  <p style="text-align: center; margin: 0;">PRESS UP</p>	<p style="background-color: #ccc; text-align: center; margin: 0;">"To deactivate it"</p>  <p style="text-align: center; margin: 0;">PRESS DOWN</p>	<p>H</p> <p>After 2 seconds the motor signals the new setting.</p>  <p>x1 1 UP Function active</p>  <p>x1 1 DOWN Function NOT active</p>	<p>I</p>  <p>The motor shows the new setting (from 1 to 5 movements). Wait 10 seconds.</p>
<p style="background-color: #ccc; text-align: center; margin: 0;">"To activate"</p>  <p style="text-align: center; margin: 0;">PRESS UP</p>	<p style="background-color: #ccc; text-align: center; margin: 0;">"To deactivate it"</p>  <p style="text-align: center; margin: 0;">PRESS DOWN</p>					

Notes:

(1) Button must be pressed shortly, approx. 0,5 seconds between two pressures.

08. OPERATING LOGIC OF COMMAND BUTTONS





This device provides the possibility to choose one of the following operating logics for the command buttons:

"Pulse" logic

This is the default mode from the factory. The motor moves up (down) if the relevant contact is closed on phase for at least 0.5 sec, the motor will stop if any one of the two contacts is closed briefly (less than 0.5 sec).

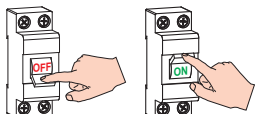
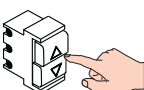
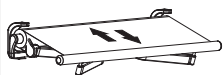
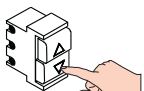
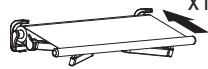
"Man present" logic

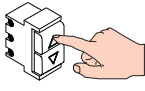
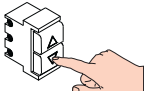
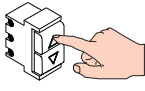
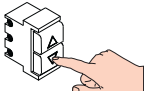
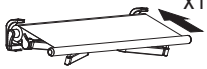
The motor moves up (down) if the relevant contact is closed on phase for at least 0.5 sec, the motor stops when contact is open.

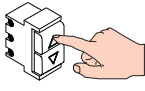
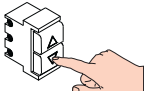
<p>A</p>  <p>Bring the motor to the intermediate position.</p>	<p>B</p>  <p>Switch OFF power supply for few seconds, then switch it ON again.</p>	<p>C ⁽¹⁾</p>  <p>3 x UP 3 x DOWN</p> <p>Within 15 seconds press 3 times on UP and 3 times on DOWN.</p>	<p>D</p>  <p>The motor completes 1 up/down movement.</p>	<p>E ⁽¹⁾</p>  <p>4 x DOWN</p> <p>Within 15 seconds, press DOWN 4 times.</p>		
<p>F</p> <p>After 15 seconds the motor shows the current setting.</p>  <p>x1 «Man present»</p>  <p>x1 «Pulse»</p>	<p>G WITHIN 15 SECONDS SELECT THE DESIRED SETTING BY PRESSING</p> <table border="1" style="width: 100%; border-collapse: collapse;"> <tr> <td style="width: 50%; padding: 5px;"> <p style="background-color: #ccc; text-align: center; margin: 0;">«Man present»</p>  <p style="text-align: center; margin: 0;">PRESS UP</p> </td> <td style="width: 50%; padding: 5px;"> <p style="background-color: #ccc; text-align: center; margin: 0;">«Pulse»</p>  <p style="text-align: center; margin: 0;">PRESS DOWN</p> </td> </tr> </table>		<p style="background-color: #ccc; text-align: center; margin: 0;">«Man present»</p>  <p style="text-align: center; margin: 0;">PRESS UP</p>	<p style="background-color: #ccc; text-align: center; margin: 0;">«Pulse»</p>  <p style="text-align: center; margin: 0;">PRESS DOWN</p>	<p>H</p> <p>After 2 seconds the motor signals the new setting.</p>  <p>x1 «Man present»</p>  <p>x1 «Pulse»</p>	<p>I</p>  <p>The motor shows the new setting (from 1 to 5 movements). Wait 10 seconds.</p>
<p style="background-color: #ccc; text-align: center; margin: 0;">«Man present»</p>  <p style="text-align: center; margin: 0;">PRESS UP</p>	<p style="background-color: #ccc; text-align: center; margin: 0;">«Pulse»</p>  <p style="text-align: center; margin: 0;">PRESS DOWN</p>					

Notes:

(1) Button must be pressed shortly, approx. 0,5 seconds between two pressures.

9. FACTORY VALUE RESET

When the anemometer is reset, all settings will return to factory values.

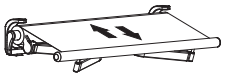
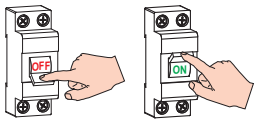
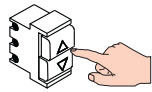
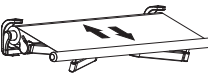
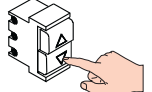
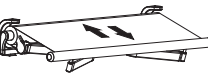
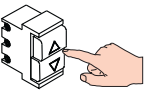
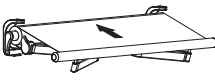
<p>A</p>  <p>Bring the motor to the intermediate position.</p>	<p>B</p>  <p>Switch OFF power supply for few seconds, then switch it ON again.</p>	<p>C ⁽¹⁾</p>  <p>3 x UP 3 x DOWN</p> <p>Within 15 seconds press 3 times on UP and 3 times on DOWN.</p>	<p>D</p>  <p>The motor completes 1 up/down movement.</p>	<p>E ⁽¹⁾</p>  <p>2 x UP 8 x DOWN</p> <p>Within 15 seconds press twice on UP and 8 times on DOWN.</p>	<p>F</p>  <p>After 15 seconds the motor performs 6 up/down movements</p>
<p>G ⁽¹⁾</p>  <p>2 x UP</p> <p>Within 5 seconds, press UP twice</p>	<p>H</p>  <p>The motor performs two brief upward movements to indicate that it was reset.</p>				

Notes:

(1) Button must be pressed shortly, approx. 1 second between two pressures.



All rights reserved.
STAFER S.p.a. - via Malpighi, 9 - 48018 Faenza (RA) ITALY
Tel. (+39) 0546.624811 - Fax (+39) 0546.623141 - www.stafer.com



All products and technical specifications given in this document are subject to variation without prior notice.
Unless previously and specifically authorised by STAFER, the device must be used exclusively with transmitters produced by STAFER.
STAFER cannot be considered responsible for damage caused by improper, incorrect or unreasonable uses.